







LSV800S3-6

Powered by Volvo **VOLVO PENTA**

-  50HZ
-  Water-cooled
-  Three Phase
-  Diesel

Model		LSV800S3-6
Standby Power	kVA	800
	kw	640
Prime Power	kVA	727
	kw	581.6
Frequency	Hz	60
Voltage	V	208/416
Rated speed	rpm	1800

LEES Volvo series gensets are with the power range of 165-770kVA.

Volvo diesel engine is small in size, light in weight, strong in anti-sudden load capacity, low in noise, reliable in economy and enjoys a good reputation all over the world.

- **Durability & Low noise**---Designed for easy, fast and economical installation. Field tested to ensure highest standard of durability and long life. Well-balanced to produce smooth and vibration-free operation with low noise level.
- **Low exhaust emission**---The state of the art, high-tech injection and highly efficient charge air system with low internal losses contributes to excellent combustion and low fuel consumption.
- **Easy service & Maintenance**---Easily accessible service and maintenance points contribute to the ease of service of the engine.

VOLVO engine → Model: TWD1645GE



VOLVO Engine: TAD1345GE	
Type	In-line, 4 stroke diesel engine with direct injection
Cylinder No.	6
Displacement	16.12L
BorexStroke	144x165mm
Compression ratio	16.8:1
Wet weight (engine only)	1810kg
Prime power at Rated RPM (without fan)	653kW/889hp
Prime power at Rated RPM (with fan)	619kW/842hp
Standby power at Rated RPM (without fan)	715kW/973hp
Standby power at Rated RPM (with fan)	681kW/927hp
Max combustion pressure at prime power	21.0MPa
Max combustion pressure at standby power	22.2MPa
Friction power	57kW/76.8hp

Fuel system @1800RPM

Prime power Specific fuel consumption at:	25%	g/kW.h	234
	50%	g/kW.h	208
	75%	g/kW.h	198
	100%	g/kW.h	194
Standby power Specific fuel consumption at:	25%	g/kW.h	229
	50%	g/kW.h	206
	75%	g/kW.h	197
	100%	g/kW.h	194

STAMFORD Alternator → Model: S5L1D-F4



Main features:

- 12 wire reconnectable stator/terminal arrangement
- Easy access for installation and maintenance
- 2/3 pitch winding as standard, to avoid excessive neutral currents
- Class H insulation with severe environmental protection as standard
- Built to conform with all leading industrial and marine standards
- 460 AVR as standard with 1.5% regulation and 2 phase sensing
- IP23 as standard

STAMFORD Alternator: S5L1D-F4	
Number of phase	3
Connecting type	3 Phase 4 Wire, "Y" type connecting
Number of bearing	1
Power factor	0.8
Protection grade	IP23
Exciter type	Brushless, self-exciting
Insulation class, Temperature rise	H/H
Telephone Influence Factor (TIF)	<50
THF	<2%
Voltage Regulation, Steady state	≤±1%
Alternator capacity	738KVA
Alternator efficiencies	94.8%
Air cooling flow	1.312m ³ /s

Alternator options

	TAL A47 F
---	-----------

Deepsea control module → Model: 7320

The DSE7320 is an Auto Mains (Utility) Failure Control Module suitable for a wide variety of diesel or gas genset applications.

Monitoring an extensive number of engine parameters, the modules will display warnings, shutdown and engine status information on the back-lit LCD screen, illuminated LEDs, remote PC and via SMS test alerts (with external modem).

The DSE7320 will also monitor the mains (utility) supply. The modules include USB, RS232 and RS485 ports as well as dedicated DSENet terminals for system expansion.



Key Features:

- 4-line back-lit LCD text display
- Five key menu navigation
- Front panel editing with PIN protection
- LED and LCD alarm indication
- Customisable status screens
- Power save mode
- Support for up to three remote display units
- 9 configurable inputs
- 8 configurable outputs
- Flexible sender inputs
- Configurable timers and alarms
- 3 configurable maintenance alarms
- Multiple date and time scheduler
- Configurable event log (250)
- Control logic facilities
- Easy access diagnostic page
- CAN and Magnetic Pick-up / Alt. Sensing
- Fuel usage monitor and low fuel alarms
- Charger alternator failure alarm
- Manual speed control
- Manual fuel pump control
- Engine exerciser
- "Protectons disabled" feature
- kW overload protection
- Power monitoring
- Load switching (load shedding and dummy load outputs)
- Automatic load transfer
- Unbalanced load protection
- Independent Earth Fault trip
- USB connectivity
- Backed up real time clock
- Fully configurable via DSE Configurable Suite PC software
- Configurable display languages
- Remote SCADA monitoring via DSE Configuration Suite PC software
- User selectable RS232 and RS485 communications
- SMS Messaging (additiional external modem required)
- Additional display screens to help with modem diagnostics
- DSENet expansion compatible
- Integral PLC editor

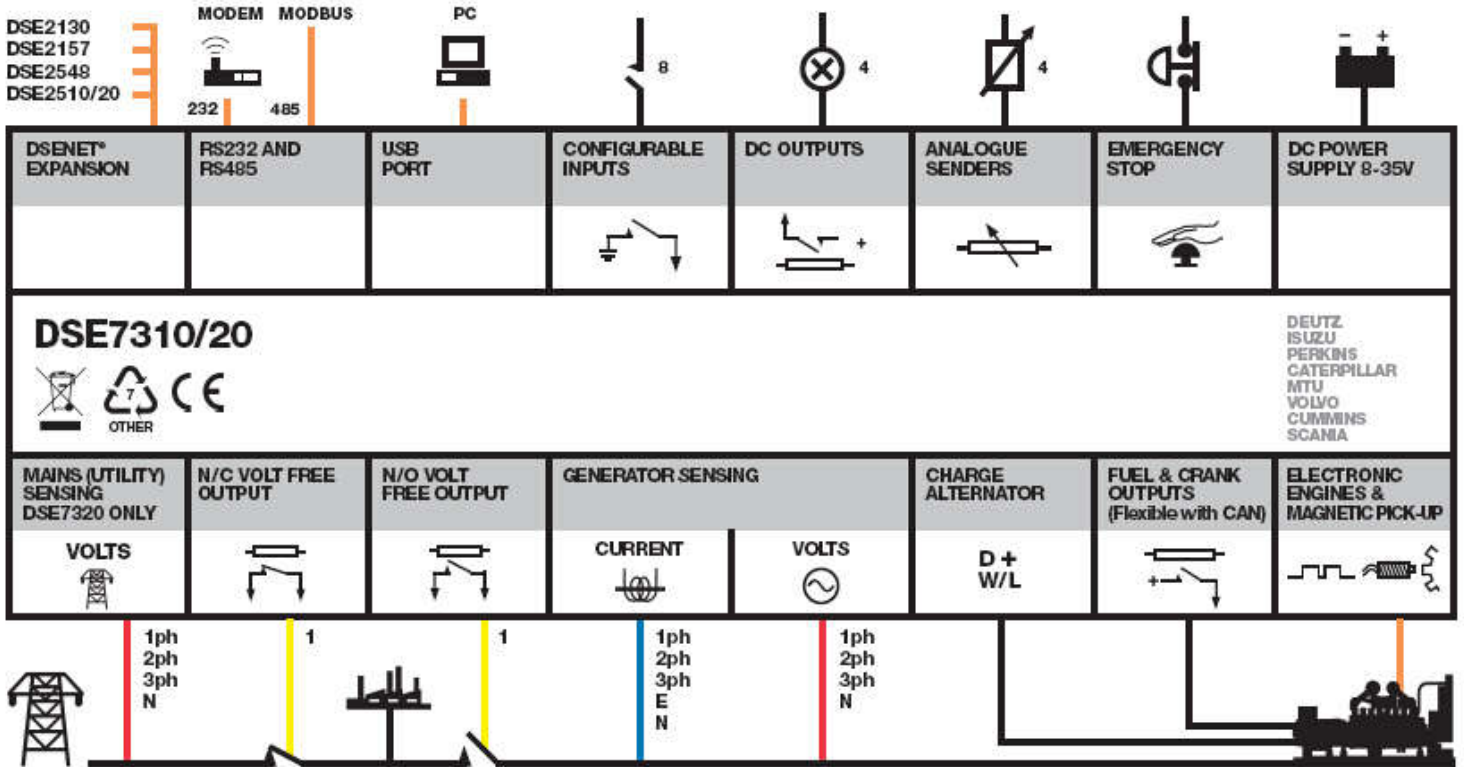
Deepsea control module → Model: 7320

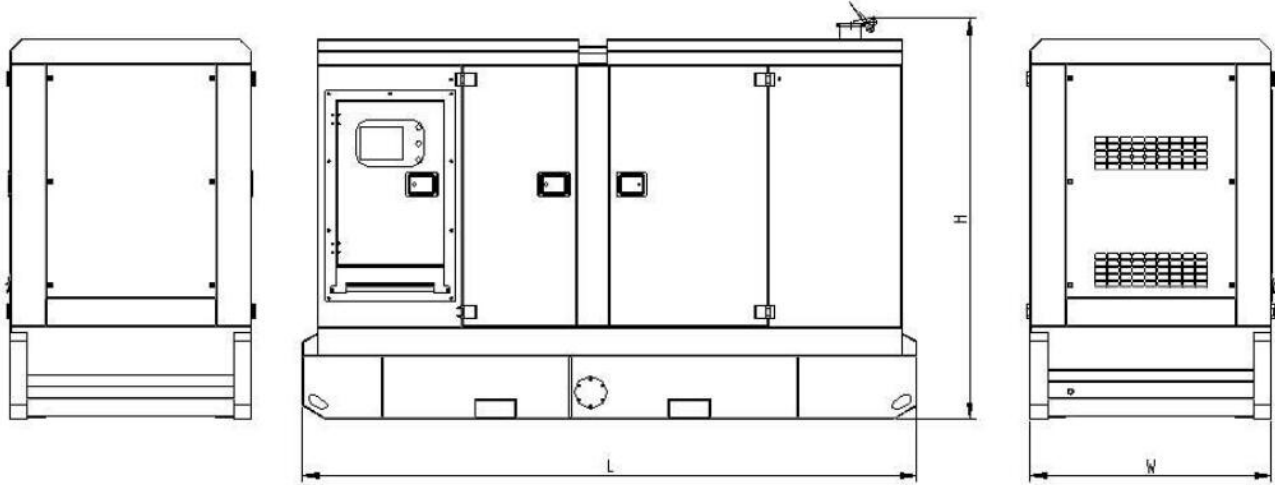

Overview dimension



LSV800S3-6 (Silent type)

Configuration	L= Length (mm)	W= Width (mm)	H= High (mm)	Gross Weight (kg)
Enclosed set	5060	1912	2530	5525

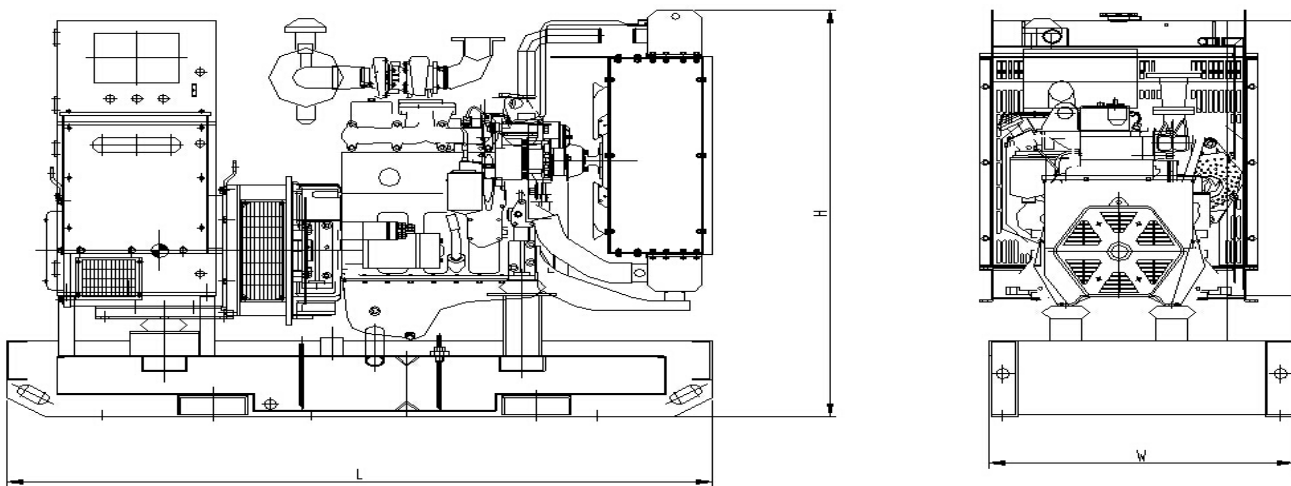

LSV800E3-6 (Open type)

Configuration	L= Length (mm)	W= Width (mm)	H= High (mm)	Gross Weight (kg)
Open set	2390	860	1850	4270

Generating Sets Standard and Optional Features

Engine:

- 4-stroke, water-cooled diesel engine
- Standard air filter
- Standard fuel filter
- Standard oil filter
- Oil temperature sensor
- Low coolant level sensor
- 24V electrical system
- Radiator with blowing fan
- Industrial silence
- **Fuel water separator (optional)**
- **Water jacket heater (optional)**

Alternator:

- Class H insulation
- IP23 Protection
- Automatic Voltage Regulator (AVR)
- PMG excitation
- Single bearing alternator
- Stamford alternator

Electrical system:

- DSE 7320 control module
- Maintenance-free and anti-explosion battery
- Standard breaker
- **ABB breaker (optional)**
- **ATS (optional)**

- **Battery charger (optional)**
- **GMS monitoring (optional)**

Packing:

- Engine manual
- Alternator manual
- Gensets operation and maintenance manual
- Tool kit

Baseframe:

- Forklift pockets
- Pulling slots
- Earth wire protection
- Built-in anti vibration mountings
- Fuel outlet valve
- Standard 8 hours fuel tank
- **Enlarged 24 hours fuel tank (optional)**
- **Separated fuel tank (optional)**

Canopy:

- Weatherproof & sound-attenuated canopy
- Sound-absorbing material
- Lifting lug
- Emergency stop button
- Inside silencer
- **Trailer generator (optional)**

Contact your distributor / dealer for more information

WUXI LEES POWER COMPANY LIMITED

NO.312 Highway, Luoshe Town, Wuxi, China, 214000

Tel: 86-510-85168446

MP: 86-13771487360

Web: www.leespowers.com

Email: lees@leespowers.com

